



INSTRUCTION MANUAL

Matos Refrigerators / Freezers

Available Models

Matos 68 R, Matos 150 R, Matos 200 R, Matos 250 R, Matos 300 R,
Matos 493 R, Matos 625 R, Matos 1365 R, Matos 1460 R
Matos 85 F, Matos 125 F, Matos 200 F, Matos 300 F

Rollex Medical

service@rollexmedical.co.nz

Contents

1. Safety Precautions	2
2. Environmental Protection and Disposal	2
3. General Characteristics.....	2
4. Before First Use	3
4.1 Placement of the Contents	4
4.2 Information on the Contents	4
5. Description of the Unit	5
5.1 Refrigerator Units	5
5.2 Freezer Units.....	5
5.3 Programming Options.....	5
6. Operating the Unit.....	6
6.1 Start-Up.....	6
6.2 Temperature Control	6
7. How to Operate the Controller	7
7.1 Control Panel	7
7.2 Simple Mode.....	8
7.4 Unit Settings.....	9
7.5 Temperature Preview	11
7.6 Programming Examples	12
7.7 Alarms.....	12
8. Optional Features	13
8.1 Over and Under Temperature Protection.....	13
8.2 Open Door Counter.....	14
8.3 Power Failure Alarm Battery Suspension.....	14
8.4 Photoperiodic System	14
8.5 Additional Temperature Sensor.....	14
8.6 Defrosting for Low Temperature Refrigerator.....	15
9. Operation of the Cooling System	15
10. Cleaning and Maintenance of the Unit.....	16
10.1 Housing Cleaning	16
10.2 Interior Cleaning	16
11. Storing the Unit for a Long Period of Time.....	16
12. Troubleshooting	17
13. Technical Details:.....	18
14. Rating Plate.....	19
15. Certificate of Compliance	20

1. Safety Precautions

The manufacturer and distributor takes no responsibility for any damage which results from incorrect use of the unit or not following these instructions.

To guarantee your security and the longest life and working efficiency of the unit, please follow these guides:

1. The unit cannot be installed:
 - Outside
 - In damp places or places which can be easily flooded
 - Near flammable or volatile substances
 - Near acids or in corrosive environments
2. You must not:
 - Store flammable or volatile substances inside the unit
 - Touch live parts of the unit
 - Operate the unit with wet hands
 - Put water vessels on the unit
 - Climb on or put any heavy objects on the unit
 - Touch the compressor and condenser whilst the unit is connected to the mains
 - Overload the shelves
3. You should:
 - Always check that the door is closed
 - Use only mains power with an earth to avoid electric shocks
 - Handle the power cable using the protective cover and not the cable itself
 - Disconnect the unit from the mains before undertaking any repairs or maintenance work
 - Protect the power cable and the plug from any damage and do not use the plug if it is improperly plugged in
 - Disconnect the power plug before moving the unit
 - Disconnect the power plug if you are not going to use the unit for a long period of time
 - Disconnect the power plug and prevent it from being reconnected if it has any visual faults

2. Environmental Protection and Disposal

The packaging protects the unit from any damage during transportation. Most of the packaging can be recycled. Please handle it according to local environmental protection regulations and dispose of it appropriately. The unit itself can also be recycled at end of life to save resources.

Please help us to protect the environment.

3. General Characteristics

Our refrigerators and freezers are used to store a variety of samples in various temperatures. Our refrigerators can work in temperatures from -10°C to +10°C and freezers from -35°C to 0°C (depending on the version). The units can be equipped with a power failure alarm with battery backup. The housings are made of painted steel sheet and interiors are aluminium or stainless steel depending on the model.

The insulation layer is made of polyurethane foam. Shelves inside the cabinet are made of polyethylene-coated steel wire and have adjustable heights on some models. The refrigerators can all be ordered with solid or glass doors, the freezers with solid doors only. At the top of the units on the front there is the control panel and on the back the main power switch.

4. Before First Use

When you first unpack the unit, check the overall condition and that any accessories are present. Any damage during transport or incomplete accessories should be reported immediately.

Whilst carrying or moving the unit, do not tilt it to one side more than 45° from the upright position as there is the possibility of damaging the compressor. If it is necessary to tilt the fridge when moving, please wait more than 3 hours before connecting the unit to the mains. If the fridge was required to be transported horizontally, please wait at least 12 hours upright before first use.

The installation location should meet the following conditions:

- Ambient temperature between 10°C and 28°C
- Low relative humidity of the ambient air below 60%
- Do not use in highly dusty environments
- The unit should be placed on a stable, level surface
- The unit should be placed at least 100mm away from the wall
- The height of the room should be at least 300mm greater than the height of the unit
- If the unit is an under-bench model, the bench should be at least 100mm from the unit and the bench should be vented for airflow
- The unit should not be exposed to direct sunlight
- The unit should be kept away from heat sources
- The unit is not designed to be built in
- The unit should be plugged into a surge protector for electrical safety

If you don't comply with the above recommendations, the unit will not run optimally and you may affect the overall life of the unit. You may also lose your warranty.

If it is not possible to locate the unit in a place that fully complies with the above conditions, make sure that at least the following points are followed:

- If the room temperature is higher than recommended, monitor the temperature in the room using an additional temperature sensor. If the room temperature goes above 45°C, the compressor will stop working to protect the compressor.
- If the room temperature is lower than recommended, under no circumstances should you turn the refrigerator on as this also may damage the compressor.
- In highly humid environments, control the frosting of the evaporator and walls more often recommended. If necessary, perform a defrost cycle manually.

Note: After locating the unit in position, secure it by locking the wheels (if they are provided on your model).

4.1 Placement of the Contents

To provide proper air circulation and stable conditions for the contents, please follow the following recommendations:

- The max height of the contents should not exceed 1/3 of the space below the shelves.
- The contents should be placed in such a way that the horizontal surface between the containers does not exceed 1/3 of the width and height of an empty shelf.
- The space between the contents, and the contents and the wall, should be more or less equal.

The picture below is an example of the placement of the contents in the chamber:

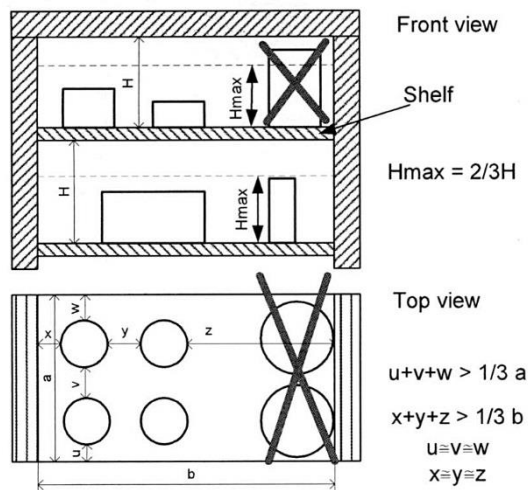

4.2 Information on the Contents

Water may gather on the bottom of the chamber. It is a result of condensation of the water vapour in the air if the set temperature is considerably lower than the ambient temperature.

The amount of water depends on the following factors:

- Differences between ambient and set temperatures
- Number and frequency of door openings
- Temperature of contents

Note: If water gathers, use a dry cloth to wipe the bottom of the chamber.

Do not use any cardboard boxes, sponges and other hygroscopic materials for storing the contents since they may increase the relative humidity in the chamber.

5. Description of the Unit

5.1 Refrigerator Units

1. RS-232C and USB socket
2. Main switch
3. Adjustable legs
4. Shelf
5. Chamber fan
6. Temperature sensor
7. Key lock
8. Electronic controller with Liquid Crystal Display (LCD)

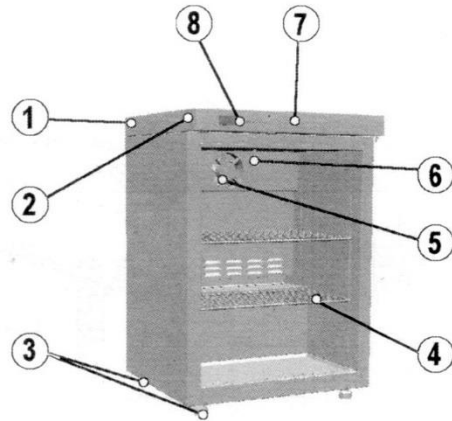

5.2 Freezer Units

1. Control panel
2. Solid door
3. Shelves
4. Cover of cooling unit

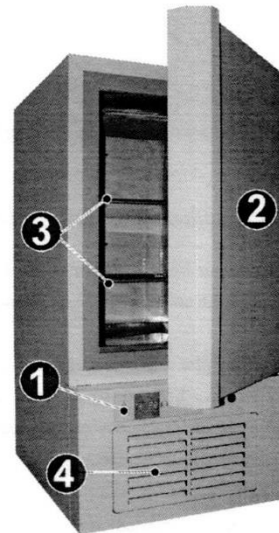

5.3 Programming Options

There are two temperature programme modes, SIMPLE and COMPLEX. Both refrigerators and freezers use the Simple mode, where the programming procedures are simplified with few parameters needed to start the programme and set the desired temperature.

6. Operating the Unit

6.1 Start-Up

To start-up the unit, please use the on/off switch that is located either in the upper front, upper left or upper rear part of the unit (depending on the model). To enter the parameters, please use the control panel which is located on the upper front part of the unit.

After the unit has been switched on, there is a self-test of the following parts performed: EEPROM memory. Data Flash memory, real time clock RTC and a temperature sensor. If the self-test has been successful, there is a current value of the temperature inside the chamber displayed on the screen. If any programme is active, its number is also displayed on the screen. To change the temperature value, please proceed according to the instructions in Chapter 7.

The time after which the unit will reach the set temperature, depends on the difference between the set temperature and the value of the current temperature inside the chamber, and the medium's heat capacity.

Equipment with a power failure alarm battery suspension option:

To start up the unit, please perform the following sequence:

- After connecting the unit to the mains, please switch it on using the on/off switch that is located on the front of the unit
- Please press down the button which is located below the control panel
- After a successful start-up, the unit will make 2 short sounds
- Operating the unit is the same as the standard version

Switching off the unit

- Please press down the button which is located below the control panel
- After a successful shut-down, the unit will make 1 long sound, and there will be no illumination of the display
- The user may switch off the unit completely using the on/off switch located on the front of the unit

6.2 Temperature Control

The unit has been adjusted and calibrated by the manufacturer. The calibration is carried out in accordance with the manufacturer's procedures and instructions using instruments which are inspected regularly.





Temperature is measured by a sensor built into the chamber and its value is displayed on the control panel. The unit has been calibrated in such a way that the display shows the temperature in the middle of the chamber.



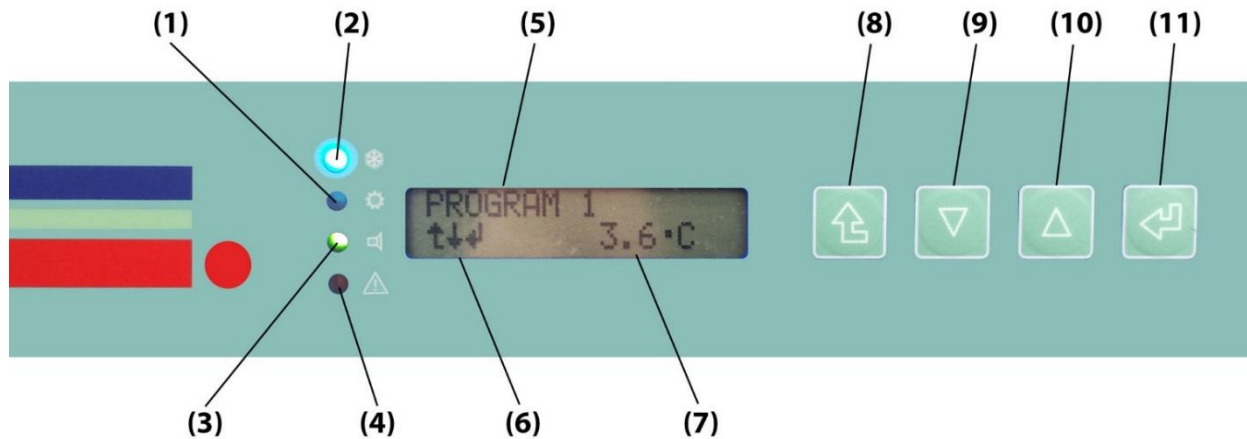



7. How to Operate the Controller

7.1 Control Panel

The control panel is used to check the current temperature inside the chamber as well as to programme and set-up the parameters of the unit.



1. Heating system signal (Orange LED)
2. Cooling system signal (Blue LED)
3. Program activation signal (Green LED). On when program is activated. Blinking when program is activated but set-point temperature hasn't been reached. Off when program is not activated.
4. Alarm signal (Red LED)
5. Alphanumeric Liquid Crystal Display
6. Arrows showing menu options available
7. LCD temperature display
8.  Escape/Exit button
9.  Menu Down button
10.  Menu Up button
11.  Enter/Accept button

The values may be changed by the following buttons:   up/down (selection keys). Confirm using the enter  button. The programme continues to set the next parameter. If the parameter value is incorrect, using the up/down   selection keys selects the parameter again and sets the correct value. To exit the current window, please press the Escape/Exit  button.

For units with internal lighting, press and hold the enter  button for about 1 second to switch on the light. When the light is on, a bulb icon will appear on the display.

Note: If the unit has been switched off during an active programme, it will automatically resume once the unit has been switched on again.

7.2 Simple Mode

After switching on the unit, the LCD shows the temperature set in the chamber. To change the value, use the up/down ▼▲ selection keys. To start working with the selected temperature, press the enter ↵ button.

Navigating the menu in Simple Mode:

Inactive program

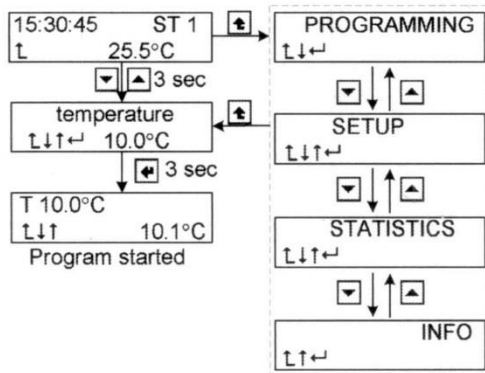

Active program

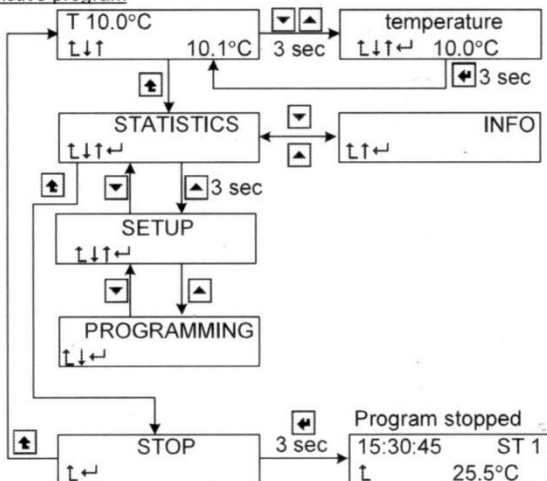

To stop the programme, press the exit ↵ button twice. You will see STOP on the display. Press and hold the enter ↵ button for at least 3 seconds.

To re-enter the temperature, press and hold the up/down ▼▲ selection keys for at least 3 seconds, set the desired temperature, then press and hold the accept ↵ button for at least 3 seconds. This starts the programme and the current temperature inside the chamber will be displayed.



Note: The SETUP and PROGRAMMING options are described later in this manual. The PROGRAMMING option is used to setup programmes to run in Complex Mode.

Description of available programme parameters:



No.	Message on the display	Set parameters	How to set it up
1	SEG1 temperature	Segment 1 parameter	[°C]: first set up degrees and then tenths of a degree
2	SEG1 time	Segment 1 duration	[dd hh:mm]: first set up the day, then the hour and minute. Time parameter = 0 means unlimited time. The unit has to be turned off manually.
3	SEG1 light*	Lights on/off	Set up 'YES' if you want to simulate daylight in current segment. Set up 'NO' if you don't need to simulate daylight.
4	delay	Start delay	[hh:mm]: first set up the hour, then the minute. Delay = 0 means no delay is set up.
5	If you choose a multi-segment time-temperature programme, you set up parameters for all the segments in exactly the same way (SEG2, SEG3... SEG6). You can also set a parameter not available for a single-segment programme – cyclicity of work.		
6	cycle	Programme cycles	The cycle mode can be activated by selecting CYCLING ON and deactivated by selecting CYCLING OFF. Turning on the cyclicity mode causes a programme to restart a programme right after it stops. The option is not available for single-segment programmes.

Note: You cannot make changes to a currently running programme – it needs to be terminated first.

Note: The operating programme allows the setting up of a single-segment Program1 programme. The Program2 and Program3 options are inactive.

After confirming the start of a programme with the enter  button, the programme will be launched. If there was a start delay set, the Green LED which signals a running programme will not switch on until the delay time has passed. You may see the delay time as well as the programme's segment and its parameters using the up/down  selection keys.

7.4 Unit Settings

To set up working parameters of the unit, go to the SETUP menu. Using the up/down  selection keys and then the accept  button, you can change the relevant options.

Description of options available in the SETUP menu:

	Message on the display		Set parameter	How to do it
1	ALARMS	CLOCK ALARM	Timer	An audible signal is emitted at a specific time, setting up the alarm [hh:mm] – is done similarly to setting up real time. The alarm can be activated selecting [ON] and deactivated by selecting [OFF]
		ALARM TEMP. LO	Undertemperature	This function allows you to define the variation from the set temperature. The variation can be set up between $\pm 0.3^{\circ}\text{C}$ and $\pm 10.0^{\circ}\text{C}$ with a 0.1°C leap or deactivated by selecting [OFF]. To set up the parameter value in the SETUP menu, select the ALARM TEMP... option and then the threshold of acceptable variation. Exceeding the allowed variation is signalled by a short audible alarm signal every five seconds until the accept  button is pressed.
		ALARM TEMP. HI	Overtemperature	

		ALARM TEMP. DELAY	Alarm display	This function allows a delay in the time after which the alarm goes off [1-30 minutes]
		POWER ALARM	Control power failure	If this function is turned ON and the programme is running, a short message pops up in the display after a power outage saying at what time the power outage occurred.
2	CLOCK		Real time	[hh:mm]: first you set up the hour then the minutes. You can change the value using the up/down ▼▲ selection keys and confirm with the accept ↵ button. The programme then automatically moves to setting the next value.
3	COMMUNICATION		Communication settings	After selecting a submenu and choosing the transmission port (USB or RS232), you can choose a protocol by pressing the enter ↵ button. Available protocols: none (interface off); EasyLabT+ (protocol complies with EasyLab-T Plus software v1.3 and higher); text (protocol for printers with serial port, EasyTemp, terminal); service (service and text protocol). After selecting a protocol with the up/down ▼▲ selection keys, you are able to adjust its settings. Print Interval: [mm:ss] sets the interval after which data is sent to the serial port (available in service and text protocols); Address [1-255] sets the address of the instrument connected to the network which is using the EasyLab-T Plus protocol.
4	DEFROSTING		Defrosting	This function is not available for freezers. To start defrosting you have to select ON using the up/down ▼▲ selection keys and press the accept ↵ button to confirm. Defrosting consists of raising the temperature of the chamber which allows for any ice in the evaporator to melt. During defrosting the display shows 'defrosting'. Pressing the up ▲ key displays the defrost cycle's remaining time (in seconds). When finished defrosting, the programme will continue with the selected profile.
5	DEFROSTING2		Defrosting for low temperature refrigerator	Option for PLUS version units. For more information, see Chapter 8.6.
6	PROTECTION		Over/under temperature protection	Option. For more in information, see Chapter 8.1.
7	PROG. MODE		Programming mode	Selecting the programming type: SIMPLE or COMPLEX modes
8	LANGUAGE		Language	This option allows for changing the language from English.
9	DOOR OPENINGS		Open door counter	Option. For more in information, see Chapter 8.2.
10	TEMP. SCALE		Choice of temperature scale	Choose between Celsius [°C] or Fahrenheit [°F] temperature scale.
11	BACKLIGHT		Controller backlight mode	Choose the controller backlight mode. FIXED means constant backlight on. TEMPORARY means that the backlight will turn off approximately one minute after the last button touch.

7.5 Temperature Preview

Whilst a programme is operating it is possible to check the average, minimum and maximum temperature values for all time-temperature segments.

Temperature values are recorded from the moment the chamber reaches the set temperature (or to be more precise, when the temperature inside the chamber reaches 0.2°C of the programmed temperature) at a ten second interval. When a programme reaches the end of a segment, the recording stops and the unit moves to the next temperature – as set for the next segment.

Once the unit reaches the next set temperature, the recording starts again. For multi-segment programmes that are available readings for each segment.

If the programme has not reached a segment yet, the display shows 'NONE DATA' - there is no data available from which the average, minimum and maximum values are calculated.

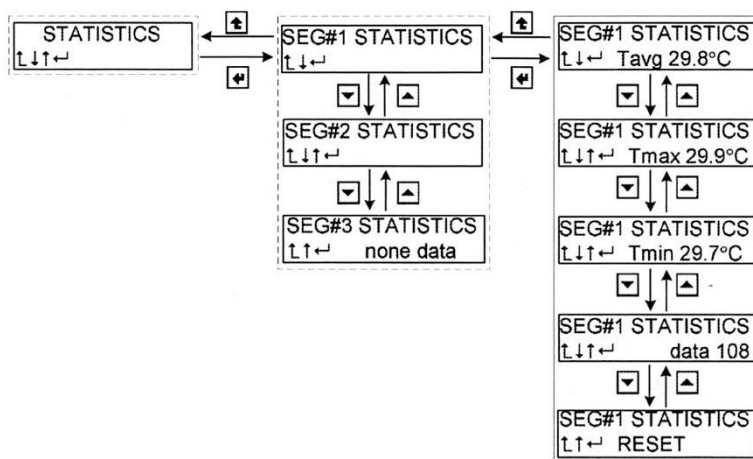



























	Message on the display	Meaning
1	SEG1... SEG6 STATISTICS	Selection of the statistics for segments 1-6
2	Tavg	Average temperature preview
3	Tmax	Highest recorded temperature preview
4	Tmin	Lowest recorded temperature preview
5	Data	Number of temperature samples for the segment
6	RESET	Temperature recorded values reset

Note: If SIMPLE mode is active, the statistics selection for the segment is omitted.

7.6 Programming Examples



The unit is to maintain +7°C for 3 hours, and programme should start with a delay of 1 hour and 30 minutes.

No.	Selected Function	Performed Action
1	Turning on the unit	Press the main power switch on.
2	Enter the programming menu	Press the exit  button, then use the up/down  selection keys to select the PROGRAMMING option and confirm with accept  button.
3	Select programme name*	Using the up/down  selection keys, select PROGRAM 1. Confirm with the accept  button.
4	Select a single-segment temperature profile	Using the up/down  selection keys, select the desired number of temperature segments for the programme and confirm with the accept  button.
5	Enter the temperature setting mode	When SEG1 TEMPERATURE is displayed, press the accept  button. Then use the  up/down  selection keys to set the value to 7 and confirm with the accept  button. Then the tenths of a degree will start flashing. Set the value to 0 using the up/down selection keys and confirm with the accept  button.
6	Enter the interval setting mode	When SEG1 TIME is displayed – the interval (duration) of the first temperature segment, press the accept  button. The display will show the currently programmed time with hours flashing. Using the up/down  selection keys, set the value to 3 and confirm with the accept  button. Minutes will start flashing, use the up/down  selection keys to set the value to 00 and confirm with the accept  button.
7	Enter the delay mode	When DELAY – start delay is displayed, press the accept  button and you will see the currently set time with hours flashing. Using the up/down  selection keys, set the value to 1 and confirm with the accept  button. Minutes will start flashing, use the up/down  selection keys to set the value to 30 and confirm with the accept  button.
8	Enter the cycle mode	When CYCLE – cyclic work is displayed, press the accept  button and you will see the currently set of cycling work YES or NO flashing. Use the up/down  selection keys to set the value to NO and confirm with the accept  button.
9	Start set programme	When START PROGRAM 1 is displayed, press the accept  button and the programme will start, confirmed with a one second audible signal. The display will then revert back to the current temperature.

7.7 Alarms

Every alarm is signalled by the red LED on the front panel, sound and ALARM text shows on the display. Press the accept  button to see the date and time of the alarm event and the type of alarm. The alarm will appear when:

1. Temperature sensor is broken.
2. The temperature inside the chamber is exceeding working range.
3. The temperature inside chamber is exceeding your programmed settings.
4. Time equals the specified time.
5. A power supply break occurred. The alarm will trigger when unit is switched back on.
6. Somebody opened the door – open door alarm.
7. No power/power failure. The unit works on battery suspension (optional).

When the cause of the alarm stops, the alarm may be cancelled by pressing the enter  button. To clear the alarm event, press and hold the enter  button for at least 3 seconds.

Sort of event	Duration of sound alarm	Red LED	Sound interval	Terminate event	Displayed command
Temperature sensor fault	0.1s	Yes	1s	Replacing of temperature sensor	SENSOR ERROR
Temperature of sensor over range	0.1s	Yes	1s	Temperature decrease/ increase till within range	RANGE OVF
Overtemperature alarm	0.1s	Yes	1s	Temperature decrease till hysteresis range	TEMP LO TEMP HI
Time alarm	1s	No	1s	Pressing of any button	TIME ALARM
Power alarm	0.1s	No	5s	Pressing EXIT button	POWER ALARM
Open door alarm	1s	No	1s	Closing door or pressing any button	DOOR OPEN

8. Optional Features

8.1 Over and Under Temperature Protection

Over and under temperature protection is an optional function. Protect – protection – contents safeguard. If the temperature sensor or the controller breaks down, or if there is a programme failure or an incidental settings change, the protection will go off.

You can choose class 2 temperature protection, class 3.2 or class 3.3. Refer to the picture below to see how it works.

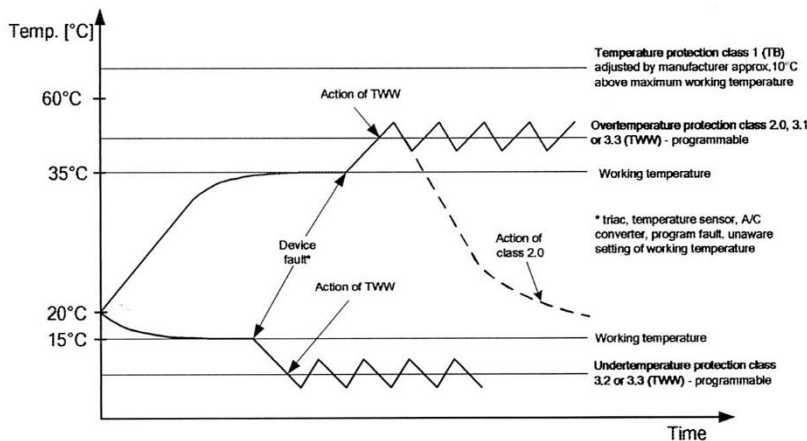

When the class 2 protection is activated, the active unit (heater or compressor) is turned off and the display shows the message that the protection has gone off. You can restart the programme after turning the unit off and on. In case of 3.2 (and 3.3) class protection, the active unit will automatically restart once the temperature reaches the allowed range. Next it needs to set the temperature when the protection activates. Activating and setting the level of protection is available in PROTECTION submenu in SETUP menu.

8.2 Open Door Counter

In submenu SETTINGS, please choose 'door count'. The following window will appear on the display.

State: 4 Mode: program

Where:

- 'State' – shows how many times the door has been open
- 'Mode' – shows the counting/cancelling mode. The user is able to choose one of 3 modes: continuous, programme or segment.

Counting the door openings depending on different modes:

- Continuous – all door openings are counted
- Programme – counting only when a programme is running (after the programme has been finished/interrupted, the door openings are not counted)
- Segment – counting the door openings only when the programme is running and when it has reached the set temperature for a segment, so the door openings are not counted when the programme is reaching the set temperature, or when the start delay is set, or it is switching to another segment, or it has finished/been interrupted/stopped.

Cancelling the open door counter depending on the mode:

- Continuous – cancelling the counter after the unit has been restarted
- Programme and Segment – cancelling when the programme has started

Additionally, for each mode it is possible to cancel the open door counter by pressing the 'enter' button for 2 seconds in the door counter window.

8.3 Power Failure Alarm Battery Suspension

It is possible to equip the unit with power failure alarm battery suspension option. This option alerts the user when there is a power failure. Moreover, it allows the user to monitor the temperature inside the chamber and change the parameters.

If there is a power failure, the programme is stopped. The alarm is signalled by a red LED light on the control panel and a short sound signals. After the power is restored, the programme is resumed.

8.4 Photoperiodic System

It is possible to equip the unit with the photoperiodic system, which allows the user to turn off the interior lighting during each segment. Therefore, it is possible to simulate day and night time. While programming each segment, it is possible to turn on/off this feature.

8.5 Additional Temperature Sensor

It is possible to equip the unit with an additional temperature sensor. In this case, during the unit's operation, there are 2 temperature values displayed on the screen and marked 1 (basic temperature sensor) and 2 (additional temperature sensor). Additionally, it is possible to record the temperature simultaneously from 2 sensors, or separately.

8.6 Defrosting for Low Temperature Refrigerator

The defrosting of the evaporator is carried out by raising the temperature inside the chamber by a few degrees and then going back to the previously defined temperature. There are 2 options available:

1. 'Auto' – automatic mode (AUTO ON/OFF) in which the controller of the unit decides to turn on the defrosting option as often as required. The defrosting is carried out by the following method: it is activated after first reaching the set temperature; or it is activated when the unit has to work hard to keep the set temperature.
2. 'Defr2. Freq' – programmable mode. User can set the frequency of defrosting with the following methods:
 - '0' – defrosting is off
 - '1' – defrosting activates once a day at midnight (00:00)
 - '2' – defrosting activates twice a day at midnight (00:00) and noon (12:00)
 - '3' – defrosting activates 3 times a day at midnight (00:00), 8am (08:00) and 4pm (16:00)
 - '4' – defrosting activates 4 times a day at midnight (00:00), 6am (06:00), noon (12:00) and 6pm (18:00)

Defrosting time can be programmed between 60 and 240 seconds. Automatic mode and programmable mode can be set to both.

Notice: Defrosting times should be setup individually and be dependent on contents. If defrosting time is set too short, ice may not melt. If defrosting time is set too long, it may cause an undesirable increase in chamber temperature.

Manual Defrost: To manually run a defrost cycle, stop the currently running programme, select 'Defrosting' and press enter to immediately start a defrost cycle, then start the programme running again.

9. Operation of the Cooling System

If the unit is operating in low temperatures the evaporator may get covered with ice. One symptom of too much ice on the evaporator is lower cooling efficiency of the unit. To ensure proper operation of the unit, you should follow these principles:

1. In temperatures above +8°C, the air automatically defrosts the ice cover, defrosting is self-operating.
2. In temperatures below +8°C, the evaporator may be covered in ice and the unit should be defrosted manually. In order to do that you need to open the door and turn on the defrost function on the controller. After the defrosting has finished, please wait approximately 30 minutes then wipe the chamber down. Not following this precaution may cause the evaporator to freeze again quickly. If the unit works at a temperature below +8°C and the user does not defrost it periodically, may make the compressor overheat and cause a breakdown.
3. The unit is equipped with a protection mechanism against damaging the cooling system. The mechanism makes it impossible to turn on cooling when the temperature exceeds 45°C. As a result, if the unit has been programmed to go down in temperature (e.g. from 60°C to 20°C) the programme will not operate until it lowers to 45°C. The temperature inside the unit is lowered naturally by emitting the heat to the surrounding environment.
4. Always make sure the door has been closed properly!

10. Cleaning and Maintenance of the Unit

Note: Before cleaning the unit, it must be disconnected from the power supply!

To clean products made of stainless steel (INOX), we recommend using cleaning solutions dedicated to stainless steel materials. It preserves the steel surface from permanent stains and at the same time retains the aesthetic appearance of the product.

When using INOX products in standard laboratory conditions they do not rust. However, it is possible that stains (that may look like rust) can form on the steel surface (due to the kind of samples that are stored in the chamber). In such cases, we recommend using cleaning solutions which are dedicated to this particular application (e.g. Pelox).

Note: When cleaning stainless steel products with dedicated cleaning solutions, you should always pay attention to specific instructions of the cleaning solution.

10.1 Housing Cleaning

1. The housing of the unit should be cleaned at least once a week depending on the working conditions.
2. The housing and door should be cleaned carefully using a soft cloth dampened with water.
3. Only mild cleaning products should be used to clean the unit.
4. Electrical parts should not get in contact with water or detergent.
5. Clean the cooling unit and condenser (exchanger) on a regular basis clean with a vacuum cleaner. These are located at the rear part of the unit. Not doing so may damage the compressor over time.

10.2 Interior Cleaning

1. The chamber should be emptied of any product/samples before cleaning.
2. Open the door of the unit and wait for any frost to melt and remove the shelves.
3. Only use water or mild detergent for cleaning.
4. During cleaning, make sure not to damage the temperature sensor built into the chamber.
5. When finished cleaning, allow the unit to dry before reinstalling shelves and restarting.

11. Storing the Unit for a Long Period of Time

1. Remove all objects from the chamber.
2. Disconnect the unit from the power supply.
3. If the unit has worked in low temperatures, please wait until any frost melts.
4. Clean and dry the chamber.
5. Leave the door open to air.
6. Store at a temperature between 0°C and 30°C and relative humidity below 70%.

12. Troubleshooting

If the unit is not working, you should check:

1. Is there a power outage?
2. Is the power cord plugged in?
3. Has the fuse blown?
4. Has the power cord been damaged?

Inefficient cooling:

1. What is the temperature outside the unit?
2. Is the door shut tight?
3. Is the condenser clean?
4. Is the unit placed in direct sunlight?
5. Is there a heat source near the unit?
6. Is the chamber overstocked or packed poorly?

Water is condensing inside the chamber:

1. Is the water outlet blocked?

Frost occurs on walls:

1. This is to be expected when working in low temperatures
2. If necessary, adjust the defrosting parameters (see 7.4)

The unit is operating too loud:

1. Is the unit leaning against furniture or other objects?
2. Are the pipes at the back in contact with anything or vibrating?
3. Is the unit level?

NOTE: A buzz or noise from decompression coming from the cooling circuit are normal noises.

13. Technical Details:

The technical data allows for $\pm 5\%$ tolerance.

MODEL		Matos 68 R	Matos 150 R	Matos 200 R	Matos 250 R	Matos 300 R	Matos 493 R	Matos 625 R	Matos 1365 R	Matos 1460 R	
Temperature range		°C	0 ... +10								
External Dimensions	Width	mm	550	600	600	600	600	635	725	1440	1440
	Height	mm	600	850	1050	1250	1450	2025	2025	2025	1970
	Depth	mm	650	600	600	600	600	810	860	860	890
Internal Dimensions	Width	mm	470	520	520	520	520	510	600	1310	1340
	Height	mm	430	660	860	1060	1260	1510	1510	1510	1460
	Depth	mm	300	420	420	420	420	640	690	690	750
	Volume	l	68	150	200	250	300	493	625	1365	1460
Shelves (default)			2	3	3	4	4	3	3	6	6
Shelf load capacity		kg	10	10	10	10	10	20	30	30	30
Maximum allowed load of the unit		kg	20	30	40	50	60	100	150	300	300
Nominal voltage		V	Value described on rating plate								
Refrigerant	Type HFC		134a							404a	
	Quantity / T	kg	0.056	0.065	0.065	0.082	0.082	0.25	0.27	0.27	0.27
	Potential GWP		1300							3784	
Quantity of Doors			1	1	1	1	1	1	1	2	2

MODEL		Matos 85 F	Matos 125 F	Matos 200 F	Matos 300 F	
Temperature range		°C	-25 ... 0	-35 ... 0		
External Dimensions	Width	mm	600	675	775	775
	Height	mm	885	1210	1380	1730
	Depth	mm	635	785	785	785
Internal Dimensions	Width	mm	420	396	496	496
	Height	mm	590	600	770	1120
	Depth	mm	395	524	524	524
	Volume	l	85	125	200	300
Shelves (default)			2	2	2	3
Shelf load capacity		kg	10	10	10	10
Maximum allowed load of the unit		kg	30	50	65	80
Nominal voltage		V	Value described on rating plate			
Refrigerant	Type HFC		404a			
	Quantity	kg	0.098	0.18	0.35	0.3
	Potential GWP		3784			

14. Rating Plate

The rating plate is located on the left wall of the unit, in the upper left corner.

Below is an example of a rating plate:



1. Name and address of manufacturer
2. Type of unit
3. Serial number
4. Temperature safety unit according with DIN12880
5. Electric shock protection: against indirect contact and IP code
6. Disposal of used unit according to 2002/96/EC
7. CE compliance mark
8. Temperature range
9. Type and weight of refrigerant
10. Maximum power consumption, weight and capacity of unit
11. Voltage and frequency of power supply

15. Certificate of Compliance

POL-EKO-APARATURA sp.j.*A. Polok-Kowalska, S. Kowalski***DECLARATION OF CONFORMITY**

POL-EKO-APARATURA sp.j.
 A. Polok-Kowalska, S. Kowalski
 ul. Kokoszycka 172c
 44-300 Wodzisław Śl.

We declare with full responsibility, that our products:

Refrigerators

Matos-Cloud 68R, 150R, 200R, 250R, 300R, 493R, 625R, 1365 R, 1465R
Matos-Eco 68R, 50R, 200R, 250R, 300R, 493R, 625R, 1365 R, 1465R

Freezers

Matos-Cloud 85 F, 125F, 200F, 300F
Matos-Eco 85 F, 125F, 200F, 300F

are produced in accordance with regulations described in following directives:

Low-voltage directive 2006/95/WE

- PN-EN 61010-1:2011 – Safety requirements in electrical measuring devices, automatics and laboratory equipment. Part 1: “General requirements”
- PN-EN 60519-1:2011 - Safety in electroheat installations - Part 1: General requirements
- PN-EN 61010-2-010:2015-01- Safety requirements for electrical equipment for measurement, control, and laboratory use - Part 2-010: Particular requirements for laboratory equipment for the heating of material
- PN-EN 60529:2003 Degrees of protection provided by enclosures (IP Code)

Electromagnetic compatibility directive 2004/108/WE

- PN-EN 61326-1:2013-06 – Electrical laboratory measurement equipment. Requirements of electromagnetic compatibility (EMC)

Directive RoHS 2011/65/EU

- PN-EN 50581:2013-03 Technical documentation for the assessment of electrical and electronic products with respect to the restriction of hazardous substances

The last two digits of the year in which the CE marking was affixed: **06**

POL-EKO-APARATURA sp.j.
 DYREKTOR

Sebastian Kowalski
 Sebastian Kowalski